

WimTec® PROOF RW

Herstelldatum ab 04/2019:

- | | | | |
|--|-----------------------------------|---------------|--------------------------|
| | WimTec PROOF RW - einfach - 9 V | Standard | Art.Nr. 132 144 |
| | WimTec PROOF RW - einfach - 9 V | HyPlus | Art.Nr. 132 137 |
| | WimTec PROOF RW - zweifach - 9 V | Standard | Art.Nr. 125 146, 128 529 |
| | WimTec PROOF RW - zweifach - 9 V | HyPlus | Art.Nr. 125 153, 128 536 |
| | WimTec PROOF RW - dreifach - 9 V | Standard | Art.Nr. 125 160, 128 543 |
| | WimTec PROOF RW - dreifach - 9 V | HyPlus | Art.Nr. 125 177, 128 550 |
| | WimTec PROOF RW - einfach - 12 V | Standard | Art.Nr. 131 857 |
| | WimTec PROOF RW - einfach - 12 V | HyPlus | Art.Nr. 131 833 |
| | WimTec PROOF RW - zweifach - 12 V | Standard | Art.Nr. 130 799, 130 805 |
| | WimTec PROOF RW - zweifach - 12 V | HyPlus | Art.Nr. 130 812, 130 829 |
| | WimTec PROOF RW - dreifach - 12 V | Standard | Art.Nr. 130 843, 130 836 |
| | WimTec PROOF RW - dreifach - 12 V | HyPlus | Art.Nr. 130 850, 130 867 |

Waschtisch und Küche

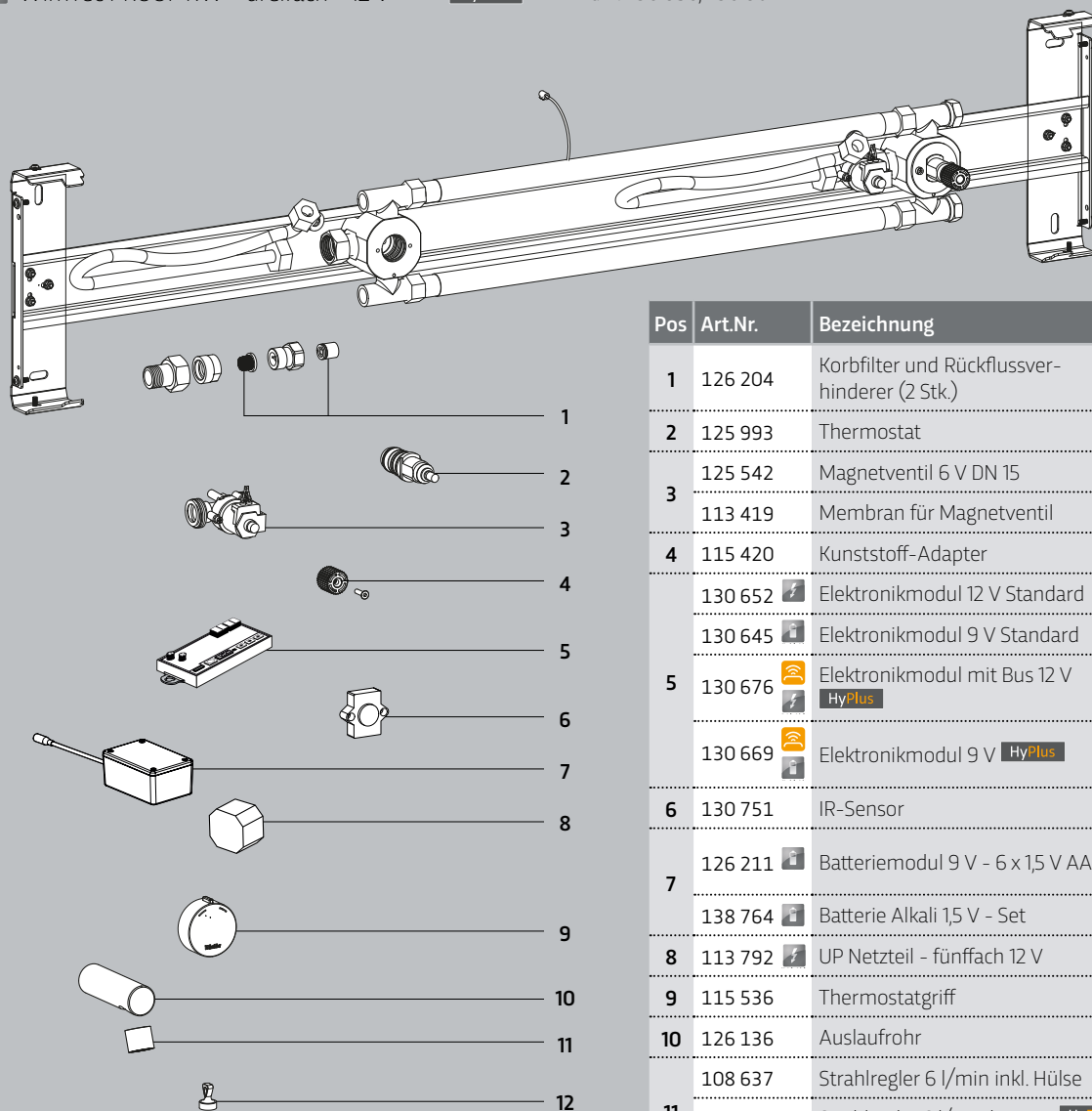









Pos	Art.Nr.	Bezeichnung
1	126 204	Korbfilter und Rückflussverhinderer (2 Stk.)
2	125 993	Thermostat
3	125 542	Magnetventil 6 V DN 15
	113 419	Membran für Magnetventil
4	115 420	Kunststoff-Adapter
5	130 652	Elektronikmodul 12 V Standard
	130 645	Elektronikmodul 9 V Standard
	130 676	Elektronikmodul mit Bus 12 V HyPlus
	130 669	Elektronikmodul 9 V HyPlus
6	130 751	IR-Sensor
7	126 211	Batteriemodul 9 V - 6 x 1,5 V AA
	138 764	Batterie Alkali 1,5 V - Set
8	113 792	UP Netzteil - fünffach 12 V
9	115 536	Thermostatgriff
10	126 136	Auslaufrohr
	108 637	Strahlregler 6 l/min inkl. Hülse
11	124 569	Strahlregler 6 l/min laminar HyPlus inkl. Hülse
	124 385	Magnetstift







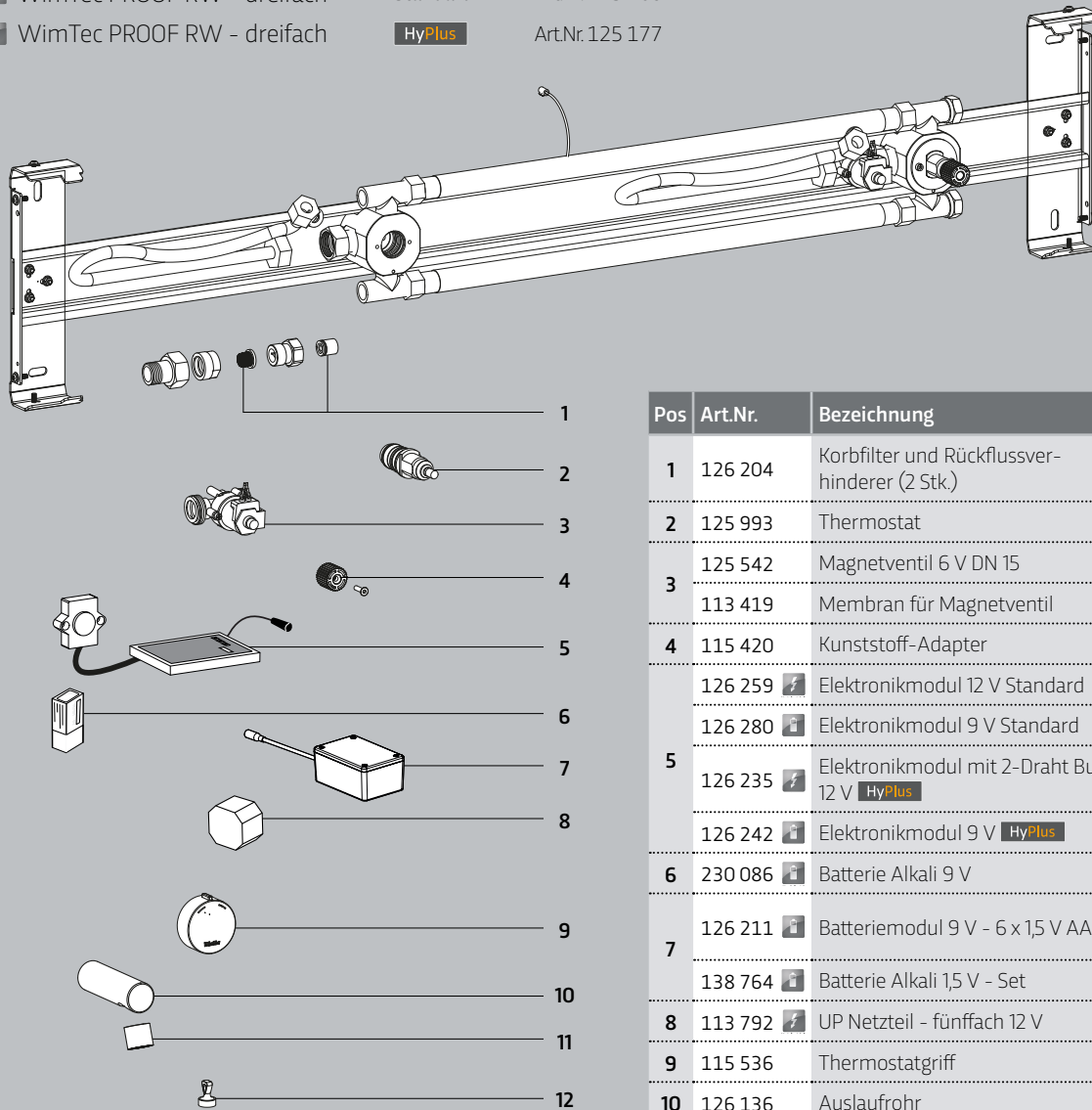

Legende: = Netzbetrieb = Batteriebetrieb = Ausführung mit thermischer Desinfektion = Kompatibel mit WimTec REMOTE
 Preise UVP exkl. MwSt. gültig ab 1. April 2025 bis 31. März 2026. Druckfehler, Irrtümer und technische Änderungen vorbehalten.

WimTec® PROOF RW

Herstelldatum bis 03/2019:

- | | | | |
|---------------------------------------------------------------------------------------------------------------------------------------------------------------------|----------------------------|---------------|-----------------|
|   | WimTec PROOF RW - zweifach | Standard | Art.Nr. 125 146 |
|   | WimTec PROOF RW - zweifach | HyPlus | Art.Nr. 125 153 |
|   | WimTec PROOF RW - dreifach | Standard | Art.Nr. 125 160 |
|   | WimTec PROOF RW - dreifach | HyPlus | Art.Nr. 125 177 |



Pos	Art.Nr.	Bezeichnung
1	126 204	Korbfilter und Rückflussverhinderer (2 Stk.)
2	125 993	Thermostat
3	125 542	Magnetventil 6 V DN 15
	113 419	Membran für Magnetventil
4	115 420	Kunststoff-Adapter
5	126 259	 Elektronikmodul 12 V Standard
	126 280	 Elektronikmodul 9 V Standard
	126 235	 Elektronikmodul mit 2-Draht Bus 12 V HyPlus
	126 242	 Elektronikmodul 9 V HyPlus
6	230 086	 Batterie Alkali 9 V
7	126 211	 Batteriemodul 9 V - 6 x 1,5 V AA
	138 764	 Batterie Alkali 1,5 V - Set
8	113 792	 UP Netzteil - fünffach 12 V
9	115 536	Thermostatgriff
10	126 136	Auslaufrohr
	108 637	Strahlregler 6 l/min inkl. Hülse
	124 569	Strahlregler 6 l/min laminar HyPlus inkl. Hülse
12	124 385	Magnetstift