

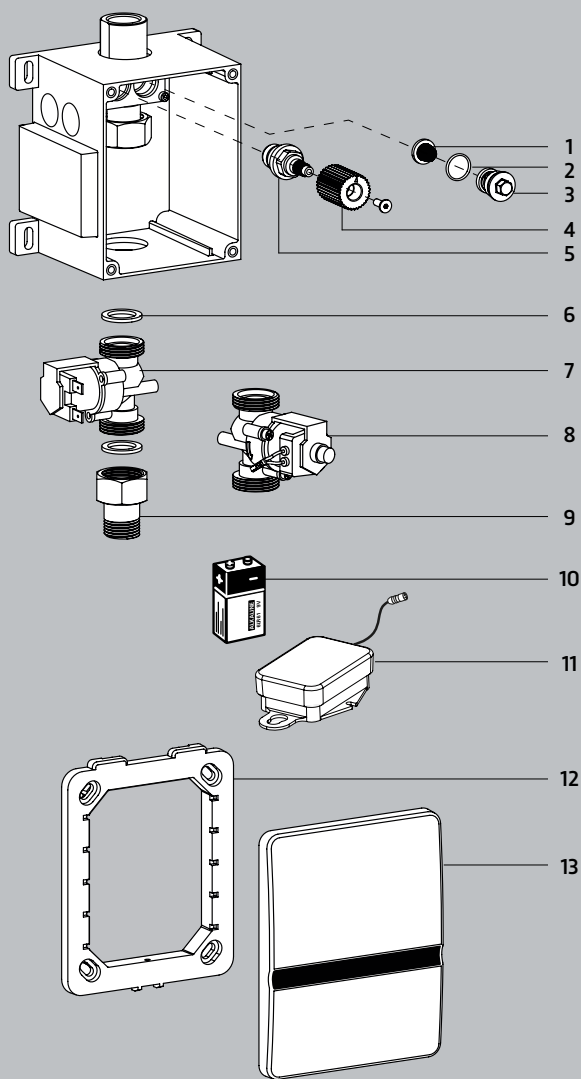

















WimTec® MULTI 2

-  WimTec MULTI 2 - 230 V  Art.Nr. 133 561, 133 578, 133 585
-  WimTec MULTI 2 - 230 V Standard Art.Nr. 121 582, 121 568, 121 575
-  WimTec MULTI 2 - 9 V  Art.Nr. 133 899, 133 905, 133 912
-  WimTec MULTI 2 - 9 V Standard Art.Nr. 121 612, 121 599, 121 605



Pos	Art.Nr.	Bezeichnung
1	119 770	Schmutzfilter (1 Stk.)
2	122 695	O-Ring
3	122 701	Schmutzsiebabdeckung (inkl. O-Ring)
4	120 547	Thermostat-Adapter
5	123 562	Sanitäröberteil
6	222 074	Dichtung $\frac{3}{4}$ " (5 Stk.)
7	221 008 	Magnetventil 24 V DN 15
8	125 542 	Magnetventil 6 V DN 15
	113 419	Membran für Magnetventil
9	221 053	Anschlussverschraubung
10	230 086 	Batterie Alkali 9 V
11	231 380 	Batteriemodul 9 V inkl. Batterie
12	122 220	Montagerahmen
Frontplatte inkl. Elektronikmodul:		
	122 718 	230 V Glanz chrom
	122 725 	230 V Matt chrom
	122 732 	230 V Weiß
	122 749 	9 V Glanz chrom
	122 756 	9 V Matt chrom
	122 763 	9 V Weiß
13	133 929 	 HyPlus 230 V Glanz chrom
	133 936 	 HyPlus 230 V Matt chrom
	133 943 	 HyPlus 230 V Weiß
	133 950 	 HyPlus 9 V Glanz chrom
	133 967 	 HyPlus 9 V Matt chrom
	133 974 	 HyPlus 9 V Weiß